









Item / Pos.	Qty. per kit / Anzahl pro Set	Content / Inhalt
00	2	O-Ring / O-Ring 
06	1	O-Ring / O-Ring 
07	1	O-Ring / O-Ring 
08	1	Diaphragm / Membrane 
17	1	O-Ring / O-Ring 
18	3	O-Ring / O-Ring 
19	1	O-Ring / O-Ring 
25	1	Spring pin / Federstift 

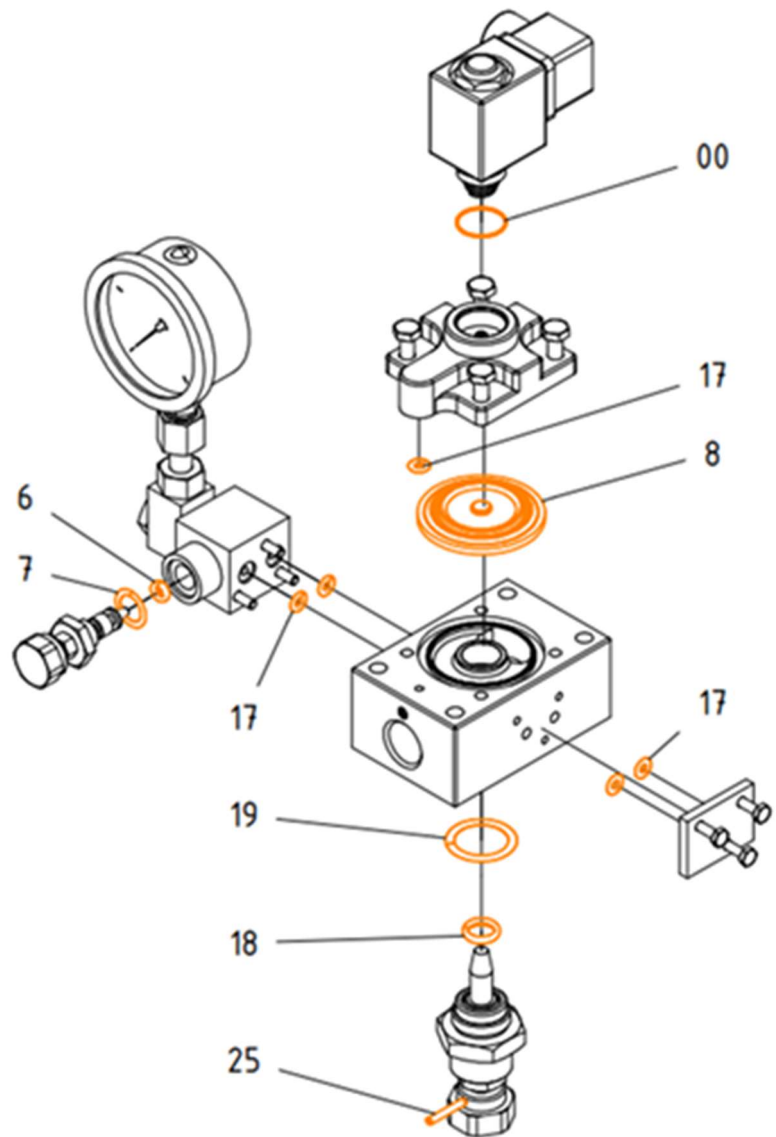

The units are supplied cleaned and degreased for possible oxygen use. Any maintenance / service should be carried out by authorized persons only.

Die Geräte wurden gereinigt und entfettet und sind für die Verwendung des Sauerstoffs geeignet. Jegliche Wartung / Service sollte nur von autorisierten Personen durchgeführt werden.